



Premier Doors
& Millworks LLC.
CATALOG



Premier Doors & Millworks LLC.

Post Office Box 2411 · 4771 Highway 200

Thompson Falls, MT 59873

Phone: 406.827-8800 · Fax: 406.827-9220

Contents ▶



Craftsmanship
Details 2

Stair | Baluster System
Selection 4

STAIRWAY STYLES

Country 5

Colonial 6

Bunker Hill 10

Georgia 14

Hampton 16

Utah 20

Contemporary 22

Mission 25

.

Box Newels 26

Treads 29

Handrails Fittings . . 30

Handrail 32

Wallrail 33

Accessories 34

.

Iron 35

Custom 39

Laskala 44

Kitchen and Bath . . 47

solid wood selections

prefinished white
High gloss white finish.
Ready to install.



primed



poplar



beech



birch



cherry



hard maple



hickory



mahogany



red oak



soft maple



brazilian cherry



walnut



white oak



yellow pine



primed, with trim



Primed Box Newels can be trimmed with any of our special species.

▼ milling options

plain



fluted



twisted



octagonal



reeded



stair | baluster system ▼



Cambered Post to Post



Cambered Over the Post



Linear Post to Post



Elegant Rise

Elegant Rise balusters are created in sets of three for each step. Measuring 34", 38" and 42" in height, their lower one-third "base" is proportioned to create a smooth, flowing line in ascent.



STRUCTURAL RISE

Structural Rise balusters are available in 5 different turning lengths: 31", 34", 36", 39" and 42", and each set has bases of identical height to emphasize individual steps in your staircase statement.

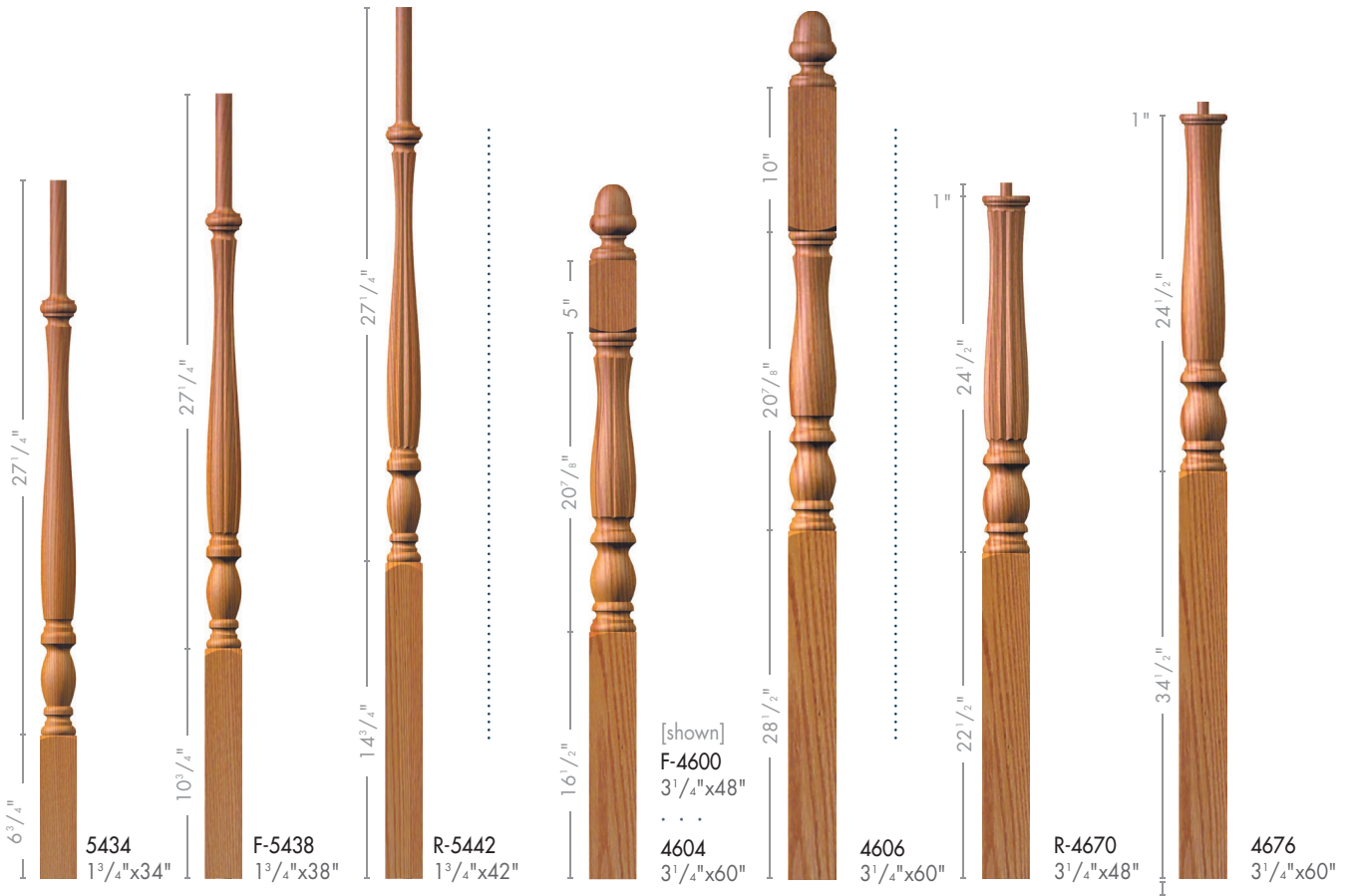

Elegant Rise
BALUSTERS

POST *Newels* to post **OVER** *Newels* the post

 Country Elegant Rise Balusters come standard with Pin-EZ Dowels for efficient installation.



Country Stairway with Reeded Parts

MILLING
OPTIONS

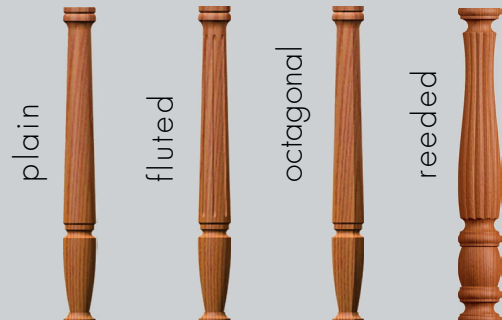

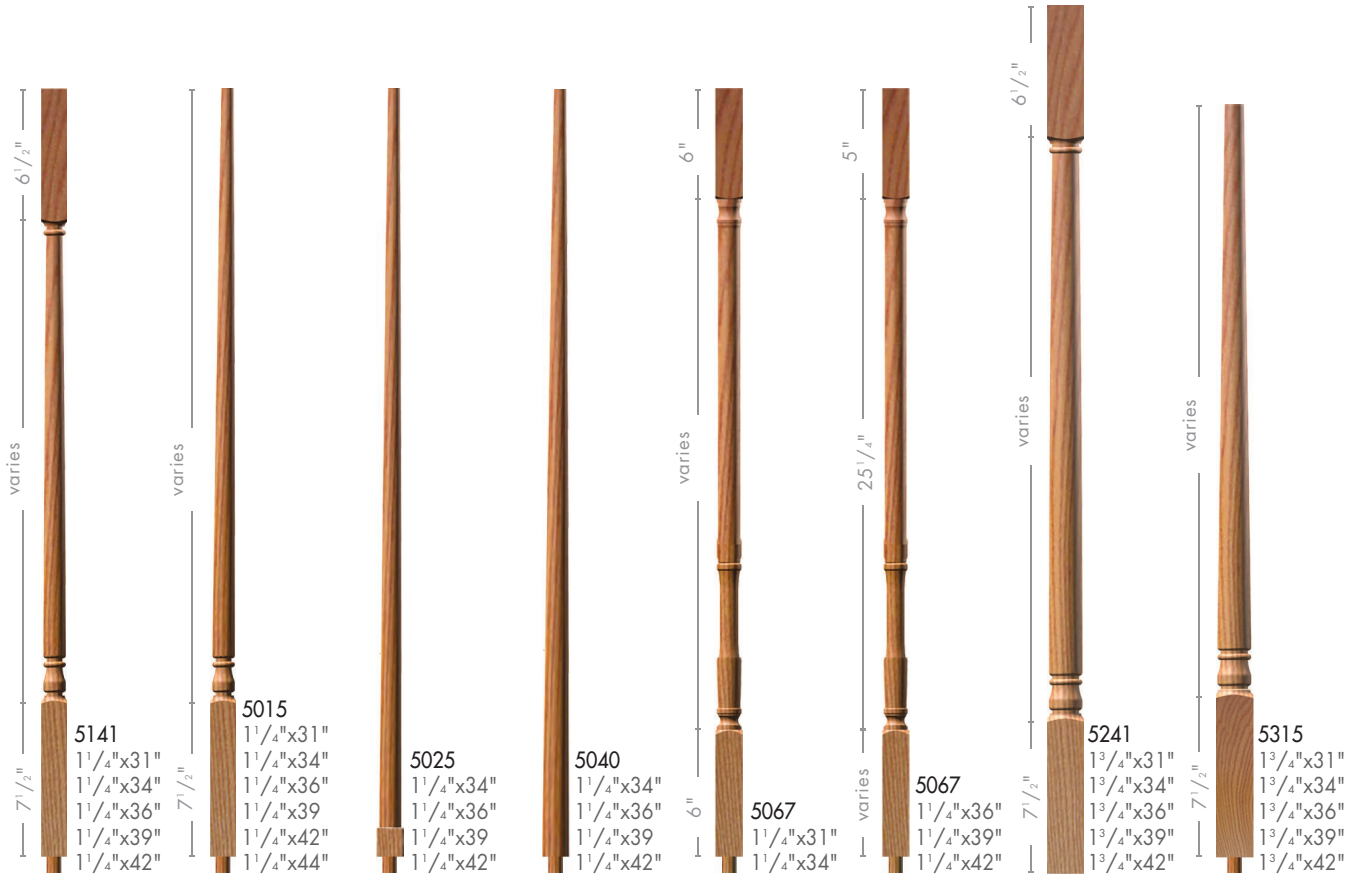

STRUCTURAL RISE BALUSTERS



Custom Stairway with Box Newel



POST

Newels to post

$2\frac{5}{8}"$
 $5"$
 $24\frac{1}{4}"$
 $15\frac{7}{8}"$
4040A
 Starting
 $3" \times 48"$

$2\frac{5}{8}"$
 $5"$
 $24\frac{1}{2}"$
 $21\frac{3}{8}"$
4042A
 Starting
 $3" \times 54"$

$2\frac{5}{8}"$
 $5"$
 $24\frac{1}{2}"$
 $27\frac{3}{8}"$
 [shown]
4043A
 Starting
 $3" \times 60"$
 . . .
4048A
 Landing
 $3" \times 72"$

$2\frac{5}{8}"$
 $5"$
 $10"$
 $19\frac{1}{2}"$
 $27\frac{3}{8}"$
4045A
 Second
 Floor
 $3" \times 60"$

$2\frac{5}{8}"$
 $5"$
 $14\frac{1}{2}"$
 $19\frac{1}{2}"$
 $23\frac{3}{8}"$
4046A
 Intermediate
 Landing
 $3" \times 60"$

$2\frac{5}{8}"$
 $5"$
 $14\frac{1}{2}"$
 $13"$
 $29\frac{3}{8}"$
4046-13
 Intermediate
 Landing
 $3" \times 60"$



$2\frac{5}{8}"$
 $5"$
 $24\frac{1}{4}"$
 $15\frac{7}{8}"$
4180
 Starting
 $3\frac{1}{4}" \times 48"$

$2\frac{5}{8}"$
 $5"$
 $24\frac{1}{2}"$
 $21\frac{7}{8}"$
4182
 Starting
 $3\frac{1}{4}" \times 54"$

$2\frac{5}{8}"$
 $5"$
 $24\frac{1}{2}"$
 $27\frac{7}{8}"$
 [shown]
4183
 Starting
 $3\frac{1}{4}" \times 60"$
 . . .
4188
 Landing
 $3\frac{1}{4}" \times 72"$

$2\frac{5}{8}"$
 $5"$
 $10"$
 $19\frac{1}{2}"$
 $27\frac{7}{8}"$
4185
 Second
 Floor
 $3\frac{1}{4}" \times 60"$

$2\frac{5}{8}"$
 $5"$
 $14\frac{1}{2}"$
 $19\frac{1}{2}"$
 $23\frac{3}{8}"$
4186
 Intermediate
 Landing
 $3\frac{1}{4}" \times 60"$

$2\frac{5}{8}"$
 $5"$
 $14\frac{1}{2}"$
 $13"$
 $29\frac{3}{8}"$
4186-13
 Intermediate
 Landing
 $3\frac{1}{4}" \times 60"$

COLONIAL ▼

OVER the post Newels

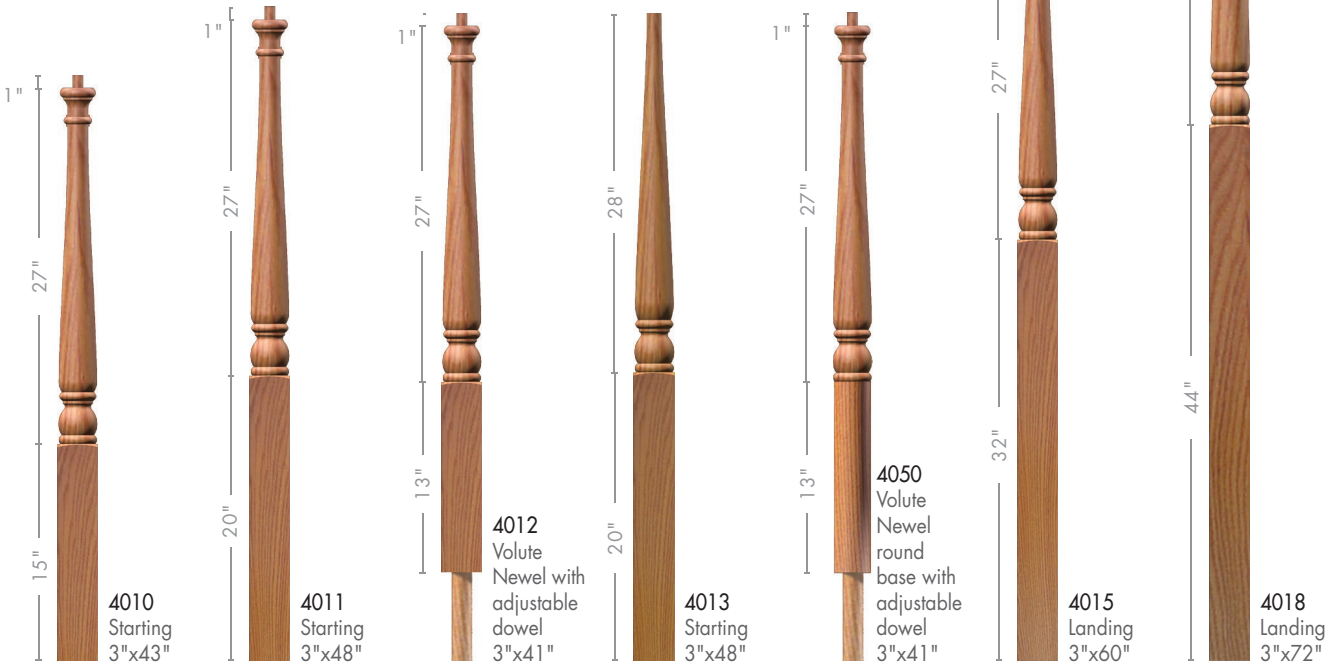

POST to post Newels



Post to post newels on this page are available with optional Balltop. Specify BT when ordering.



Elegant Rise

BALUSTERS

 Colonial Elegant Rise Balusters come standard with Pin-EZ Dowels for efficient installation.



Colonial Stairway with Elegant Rise. Featuring 81-Series Balusters.



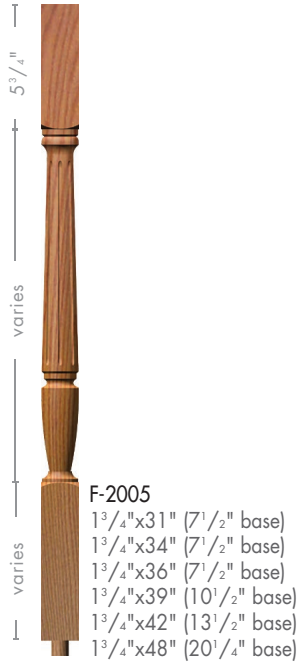
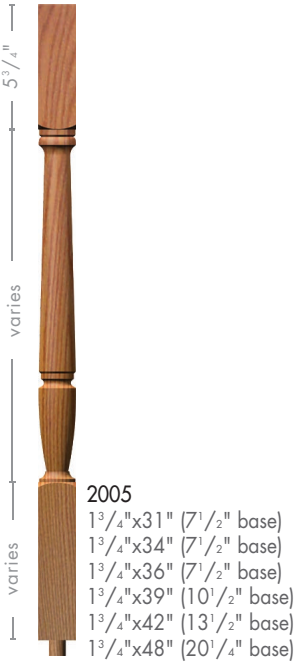

STRUCTURAL RISE BALUSTERS



Bunker Hill Stairway with Elegant Rise. Featuring 22-Series Balusters

MILLING OPTIONS

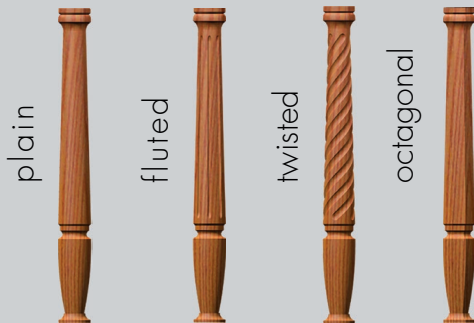

STRUCTURAL RISE BALUSTERS

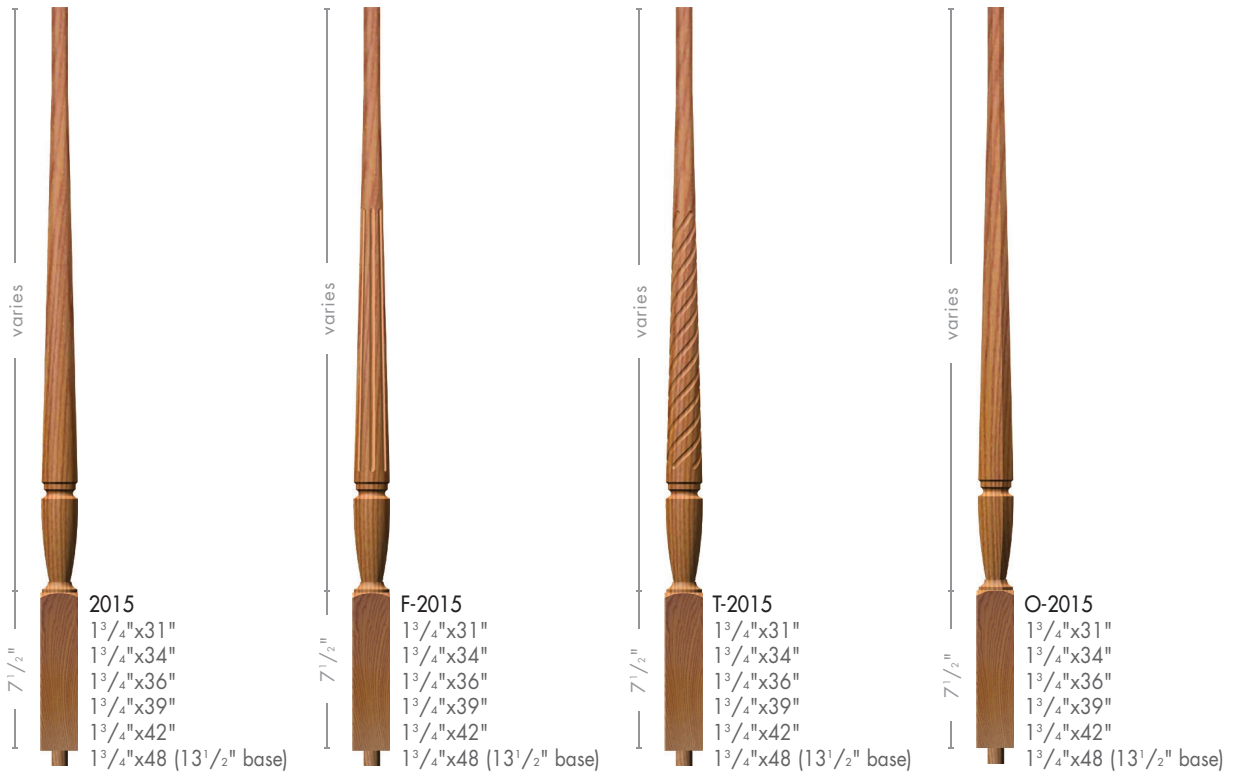

Elegant Rise BALUSTERS

 Bunker Hill Elegant Rise
Balusters come standard with Pin-EZ
Dowels for efficient installation.

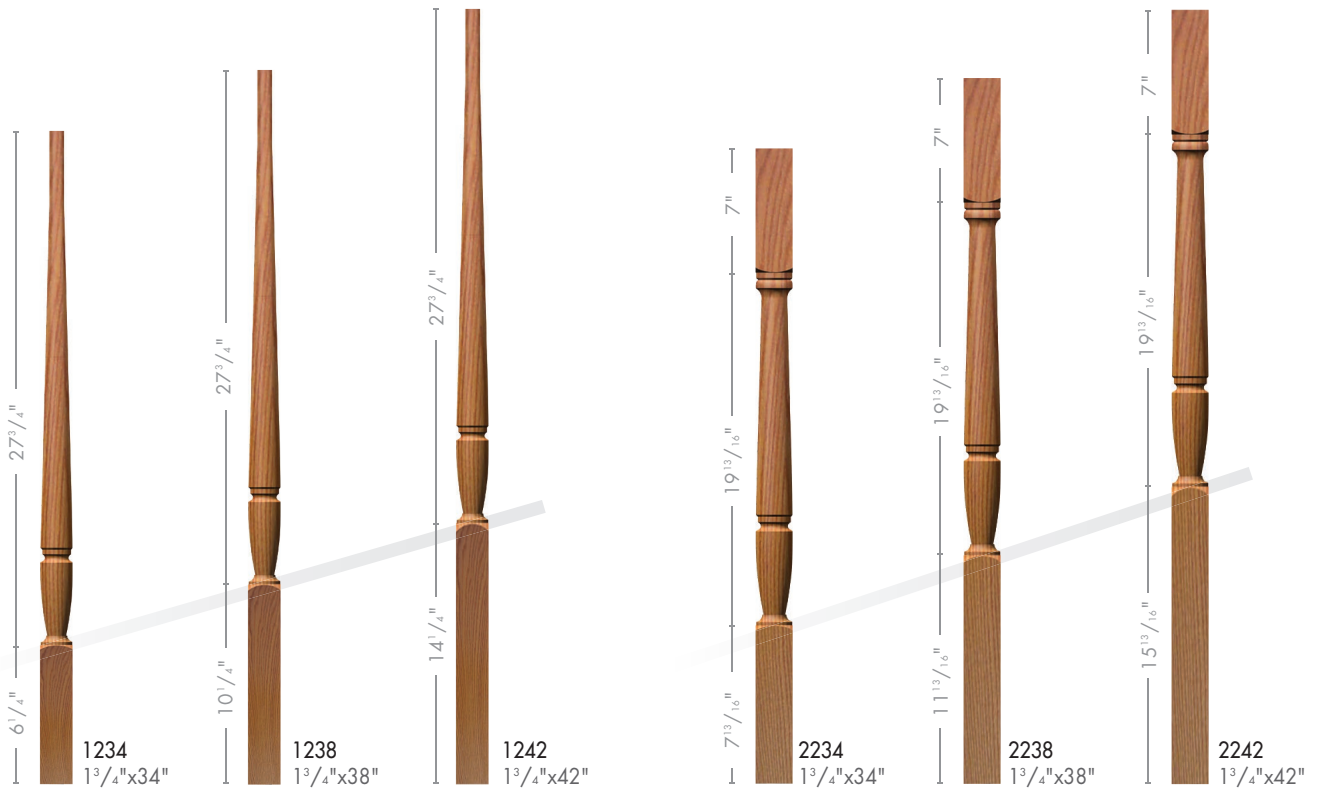

BUNKER HILL ▼

POST

Newels to post

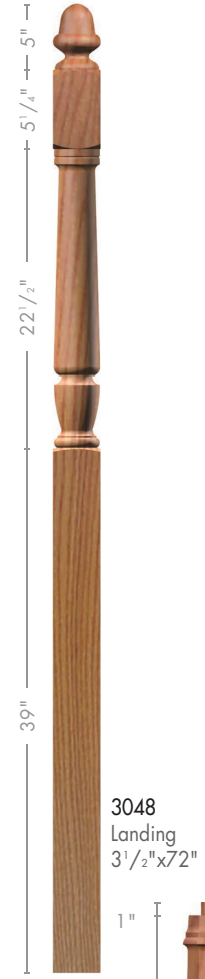
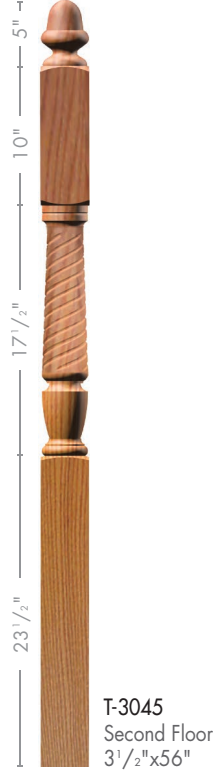
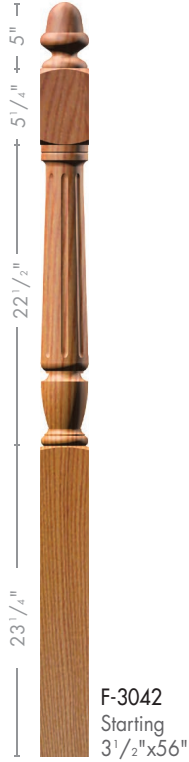

OVER

the post

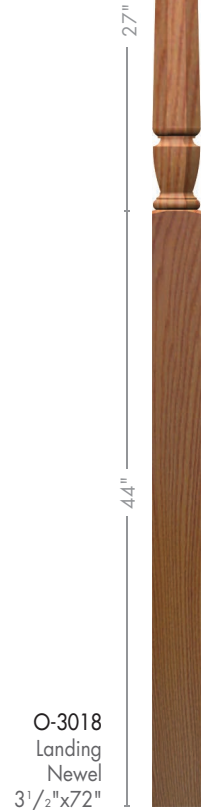
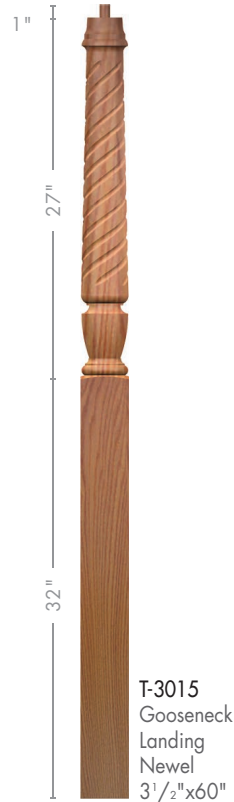
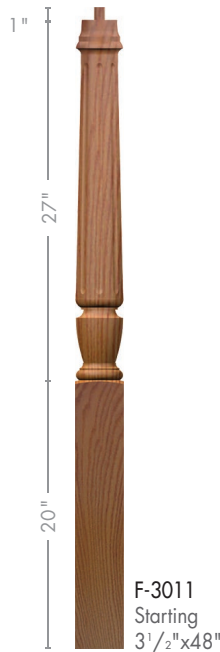
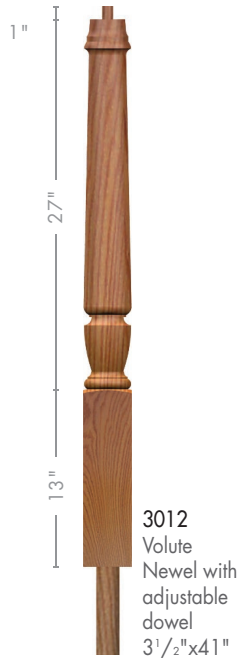
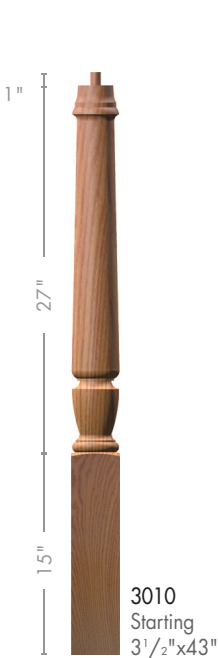

Interchangeable Finials



PA-410
Plain Acorn



CA-411
Carved Acorn



OCT-415
Octagon Pineapple



PP-412
Plain Pineapple



CP-414
Carved Pineapple



RCP-413
Raised Carved Pineapple



PB-416
Ball Top

POST

Stencils to post
with interchangeable finials



4130
Starting
3 1/2" x 43"



F-4132
Starting
3 1/2" x 51"



T-4135
Second Floor
3 1/2" x 51"



O-4136
Intermediate
Landing
3 1/2" x 51"

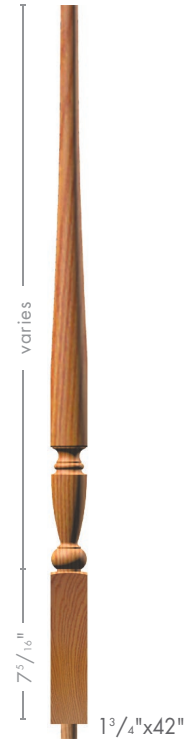

STRUCTURAL RISE
 BALUSTERS



Custom Stairway.

MILLING
 OPTIONS

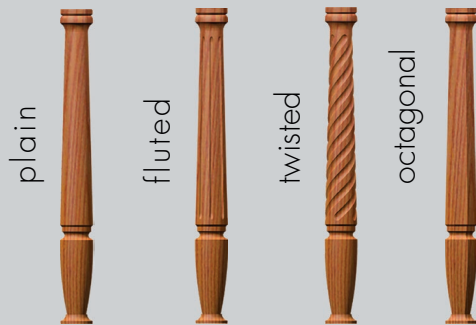

POST

Stewels to post



OVER

Stewels the post

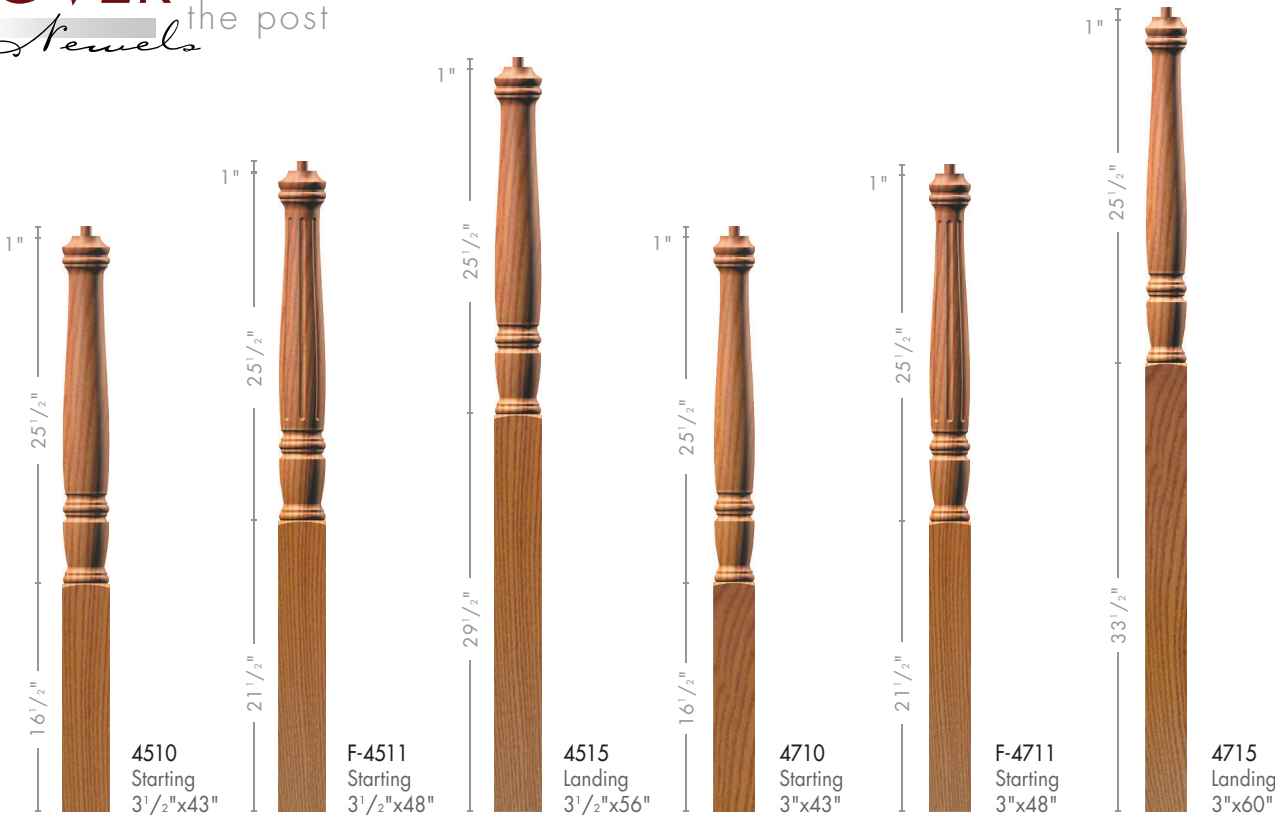

HAMPTON

stairways

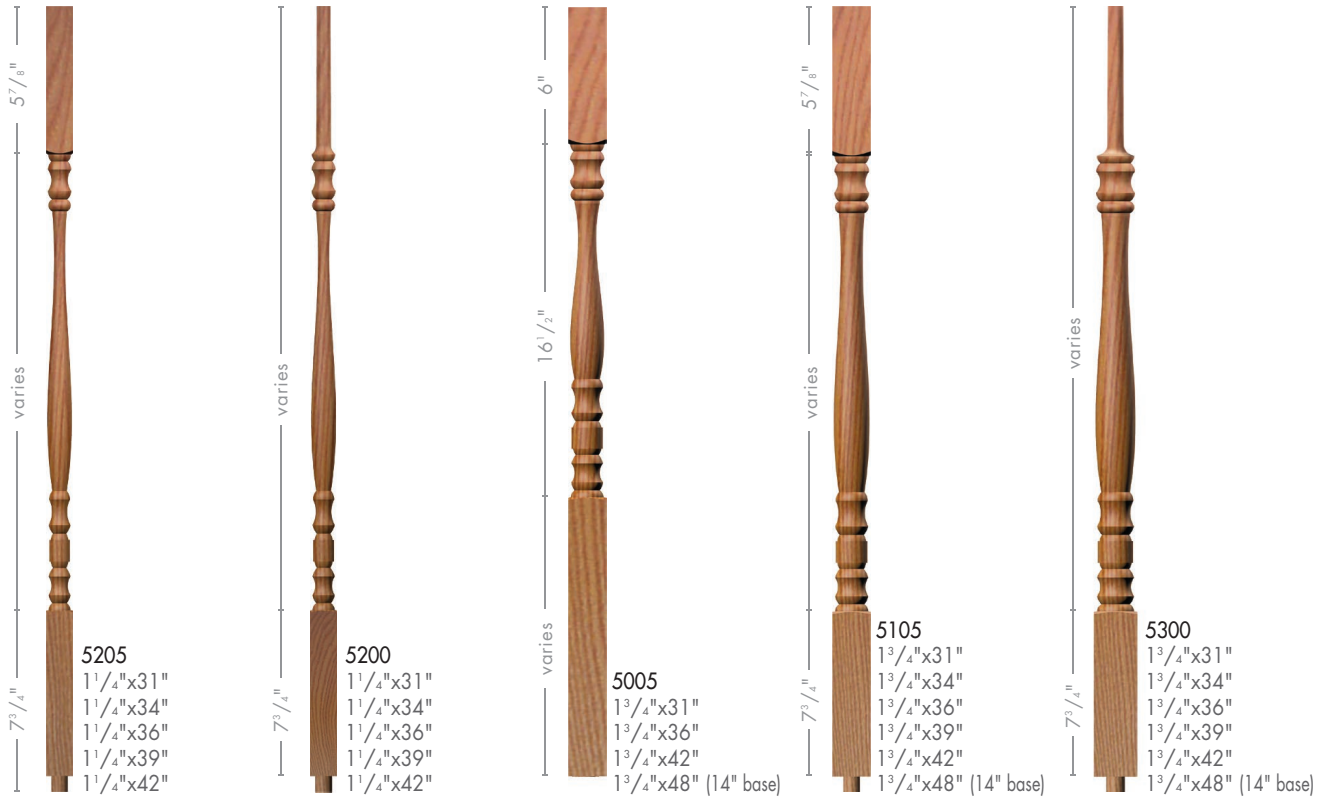

STRUCTURAL RISE BALUSTERS



Fluted Box-Newels. Featuring Custom Balusters.

MILLING OPTIONS

plain

octagonal
on $1\frac{3}{4}''$ only

Elegant Rise

BALUSTERS

 Hampton Elegant a Balusters come standard with Pin-EZ Dowels for efficient installation.



POST

Stewels to post



OVER the post *Newels*



4270
Starting
3 1/2" x 43"



4272
Volute
Newel with
adjustable
dowel
3 1/2" x 41"



4272-RB
Volute
Newel
round
base with
adjustable
dowel
3 1/2" x 41"



O-4271
Starting
3 1/2" x 48"



4271
Starting
3 1/2" x 48"

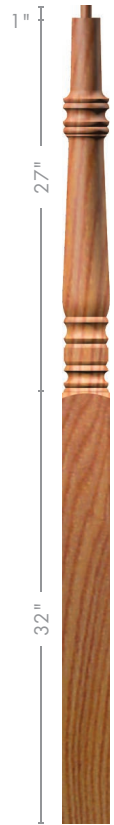

[shown]
4275
Gooseneck
Landing
3 1/2" x 60"
• • •
4278
3 1/2" x 72"

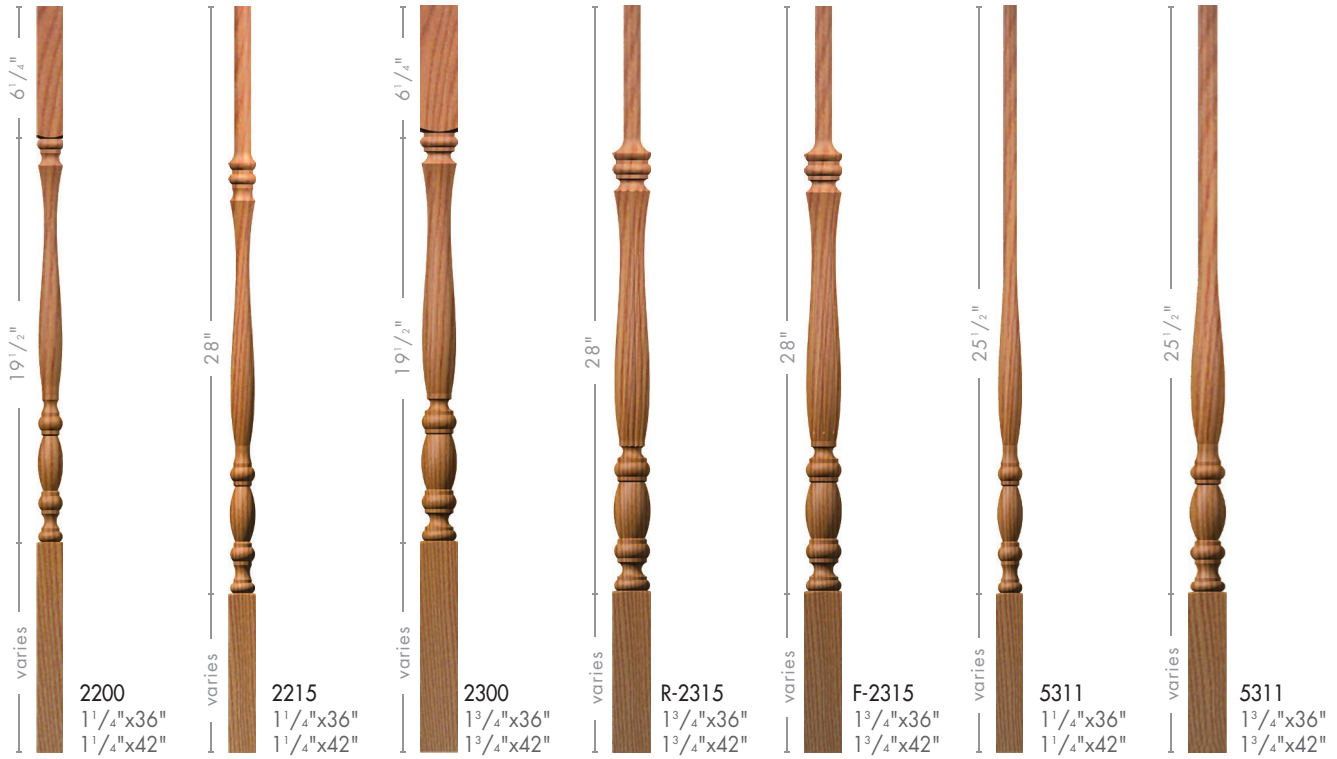

Elegant Rise

BALUSTERS



Country Stairway with Reeded Balusters.

MILLING OPTIONS

- plain
- fluted
- octagonal
on 1 3/4" only
- reeded

POST

Stewels to post

Technical drawings of six different wood post styles. Each drawing shows the post with its dimensions and product information.

- Post 1:** Dimensions: 1 6 1/2" (bottom), 23" (middle), 5" (top), 3 1/2" (total). [shown] 5548 Starting 3 1/2"x48". . . . 5748 Starting 3"x48".
- Post 2:** Dimensions: 28 1/2" (bottom), 23" (middle), 5" (top), 3 1/2" (total). [shown] F-5560 Starting 3 1/2"x60". . . . 5760 Starting 3"x60".
- Post 3:** Dimensions: 25 1/2" (bottom), 16 1/2" (middle), 14 1/2" (top), 3 1/2" (total). [shown] R-5546 Intermediate Landing 3 1/2"x60". . . . 5746 Intermediate Landing 3"x60".
- Post 4:** Dimensions: 23 1/2" (bottom), 19 1/2" (middle), 10" (top), 3 1/2" (total). [shown] 5545 Second Floor 3 1/2"x60". . . . 5745 Second Floor 3"x60".
- Post 5:** Dimensions: 23 1/2" (bottom), 19 1/2" (middle), 10" (top), 3 1/2" (total). F-5545 Second Floor 3 1/2"x60".

OVER

Stewels the post

Technical drawings of three different wood post styles. Each drawing shows the post with its dimensions and product information.

- Post 1:** Dimensions: 1" (top), 23" (middle), 24" (bottom). [shown] 5511 Starting 3 1/2"x48". . . . 5711 Starting 3"x48".
- Post 2:** Dimensions: 1" (top), 23" (middle), 24" (bottom). [shown] F-5511 Starting 3 1/2"x48". . . . 5711 Starting 3"x48".
- Post 3:** Dimensions: 1" (top), 23" (middle), 36" (bottom). [shown] R-5515 Starting 3 1/2"x60". . . . 5715 Starting 3"x60".



Utah Stairway with #2315 Balusters.

CONTEMPORARY *stairways*



5060 S4S
 1 1/4" x 31"
 1 1/4" x 34"
 1 1/4" x 36"
 1 1/4" x 38"
 1 1/4" x 39"
 1 1/4" x 42"



5061 S4S
 with dowel
 1 1/4" x 31"
 1 1/4" x 34"
 1 1/4" x 36"
 1 1/4" x 38"
 1 1/4" x 39"
 1 1/4" x 42"



5360 S4S
 1 3/4" x 31"
 1 3/4" x 34"
 1 3/4" x 36"
 1 3/4" x 38"
 1 3/4" x 39"
 1 3/4" x 42"



4004BT
 3 1/2" x 48"
 . . .
 4005BT
 3 1/2" x 56"
 . . .
 4006BT
 3 1/2" x 72"



4004
 3 1/2" x 48"
 . . .
 4005
 3 1/2" x 56"
 . . .
 4006
 3 1/2" x 72"



4000-60
 Chamfered Top
 3" x 60"
 . . .
 4000-48
 Chamfered Top
 3" x 48"



4002-60
 Chamfered Top
 3 1/2" x 60"
 . . .
 4002-48
 Chamfered Top
 3 1/2" x 48"



4001-60
 S4S
 3" x 60"
 . . .
 4001-48
 S4S
 3" x 48"



4003-60
 S4S
 3 1/2" x 60"
 . . .
 4003-48
 S4S
 3 1/2" x 48"



Contemporary Stairway with #5360 Balusters.

MILLING OPTIONS

plain



fluted



octagonal
 on 1 3/4" only



Elegant Rise

BALUSTERS

contemporary fluted

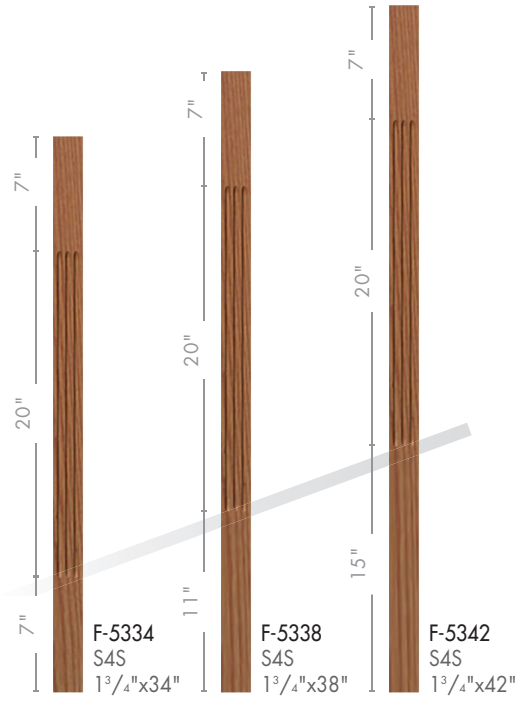
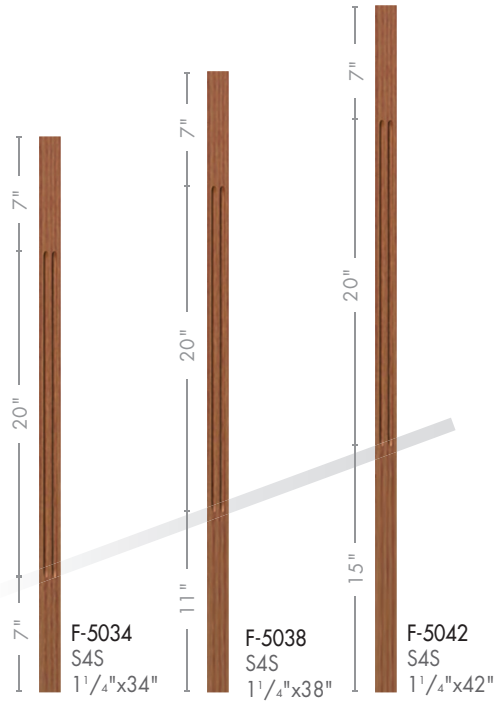

POST

Stewels to post

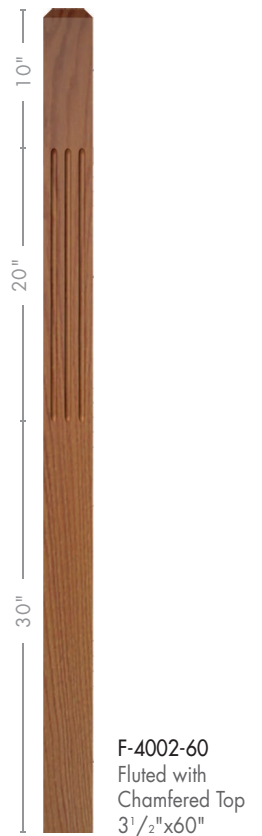
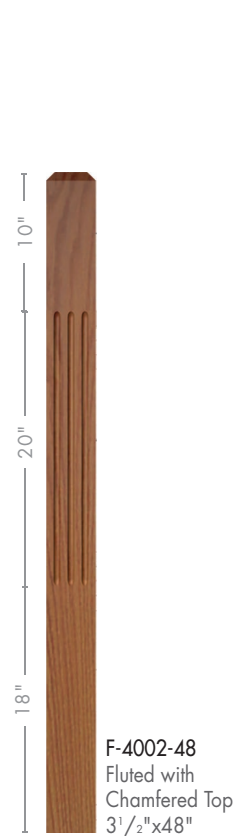
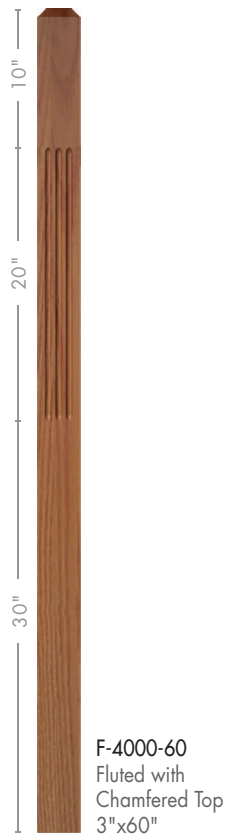
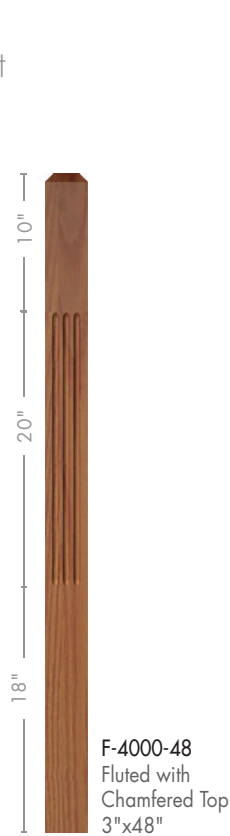

CONTEMPORARY ▼

contemporary chamfered

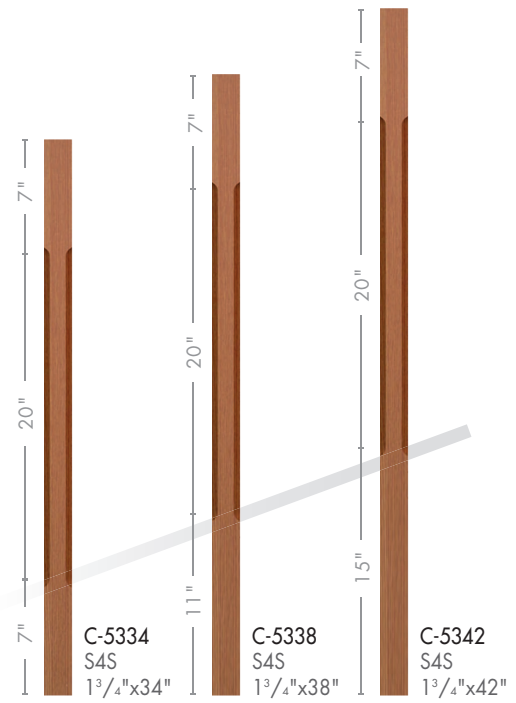
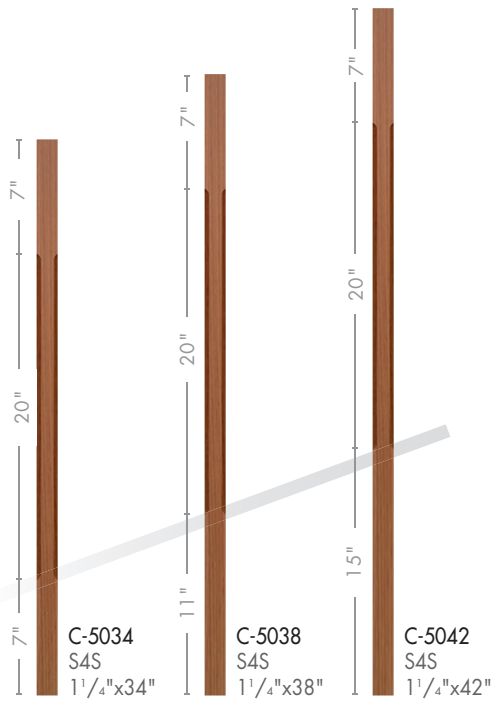

POST

Stewels to post

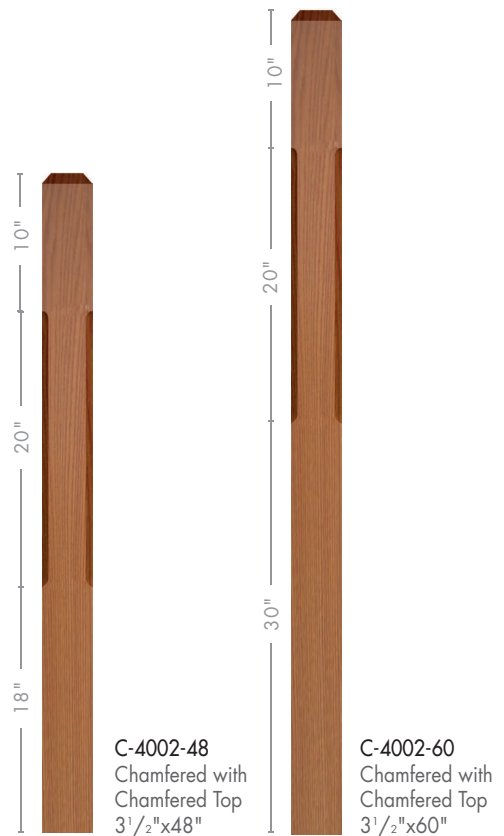
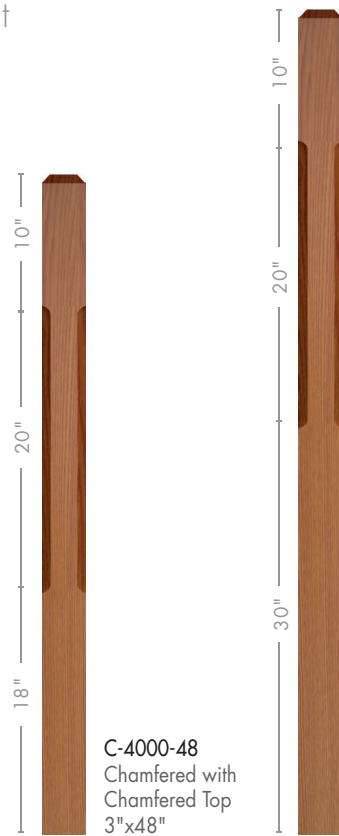

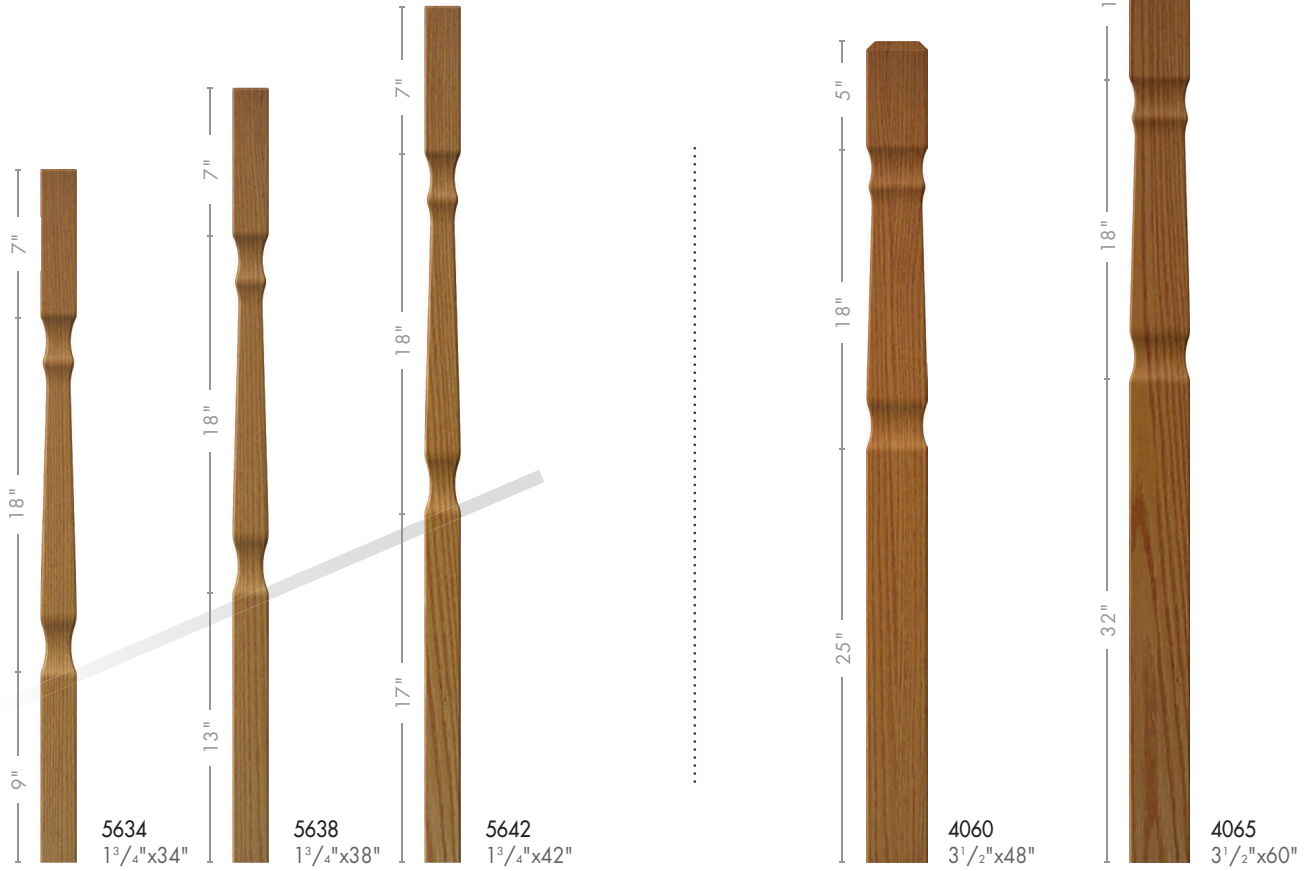

Elegant Rise
BALUSTERS

POST
Newels to post



Fluted Box Newels with Custom Balusters

BOX NEWELS

stairparts



All Box Newels are available primed with unfinished caps and trim.



4091 Box Newel
 6 1/4" x 55"
 6 1/4" x 63"
 6 1/4" x 72"



F-4091 Fluted Box Newel
 6 1/4" x 55"
 6 1/4" x 63"
 6 1/4" x 72"



AFP-4091 Flat Panel Box Newel
 6 1/4" x 55"
 6 1/4" x 63"
 6 1/4" x 72"



ARP-4091 Raised Panel Box Newel
 6 1/4" x 55"
 6 1/4" x 63"
 6 1/4" x 72"

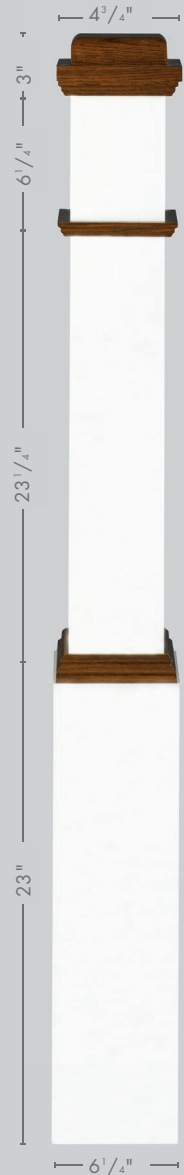

4091 Primed
 6 1/4" x 55"
 6 1/4" x 63"
 6 1/4" x 72"

Primed box newels can be trimmed with any of our special species

In addition to our standard line of box newels we offer custom styles in a wide variety of species.

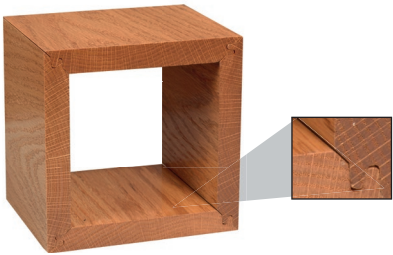

Box Newels are made with lock miter corners. Which means they have no edge grains, developing elegance.

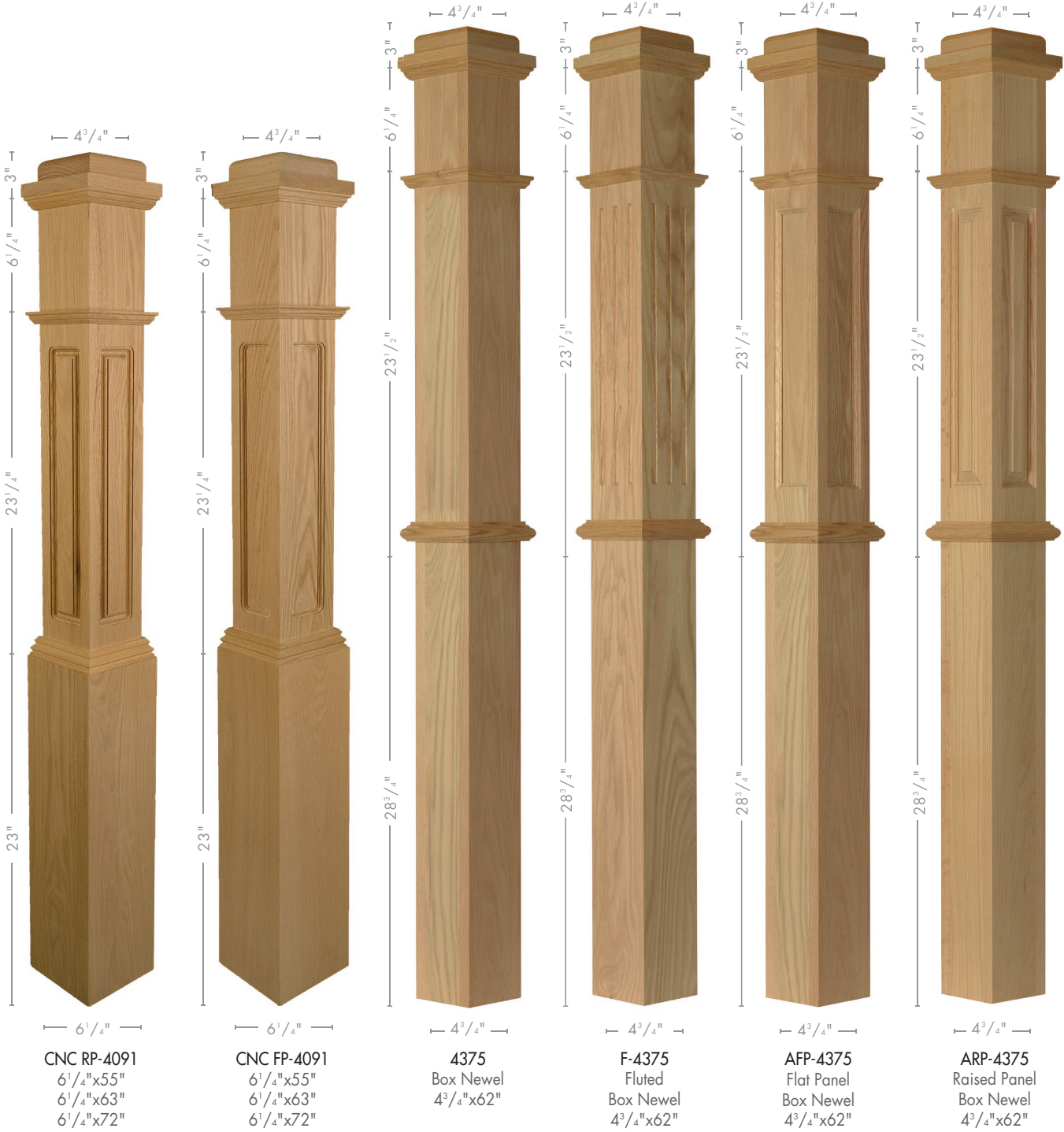

BOX NEWELS STAIR PARTS



4075
Box Newel
3 1/2" x 58"



F-4075
Fluted
Box Newel
3 1/2" x 58"



4092 Box Newel
7 1/2" x 55"
7 1/2" x 63"
7 1/2" x 72"



F-4092 Box Newel
7 1/2" x 55"
7 1/2" x 63"
7 1/2" x 72"



AFP-4092 Box Newel
7 1/2" x 55"
7 1/2" x 63"
7 1/2" x 72"



ARP-4092 Box Newel
7 1/2" x 55"
7 1/2" x 63"
7 1/2" x 72"

CONTINUED ON PAGE 36



1148
Plain Tread
11 1/2" x 48"*



1148-DMR
Double Return Tread
11 1/2" x 48"*



1148-LR
Single Return Tread
11 1/2" x 48"*

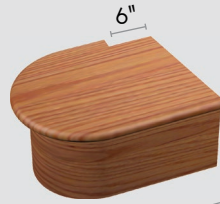

8010-2
False End and Riser · 12 1/2" x 18"
8310-2
False End and Riser · 14" x 18"

6"
18"
(overall length)



8060
Double End Quarter
Circle Starting Step
11 1/4" x (varies)*

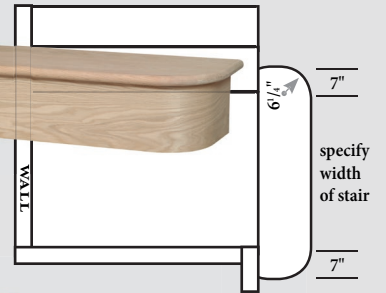

8015
Double End Starting Step · 12 1/2" x (varies)*
8315
Double End Starting Step · 14" x (varies)*

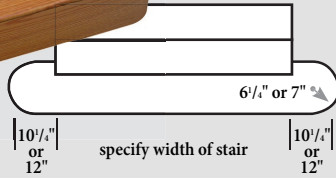

8040
Single End Quarter
Circle Starting Step
11 1/4" x (varies)*

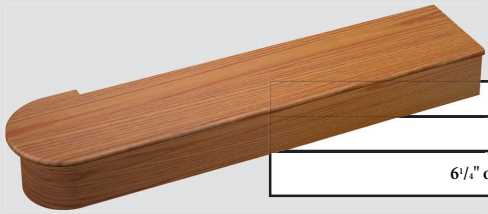
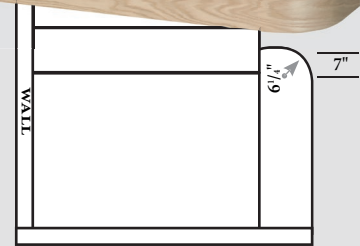

8010
Single Starting Step · 12 1/2" x (varies)*
8310
Single Starting Step · 14" x (varies)*

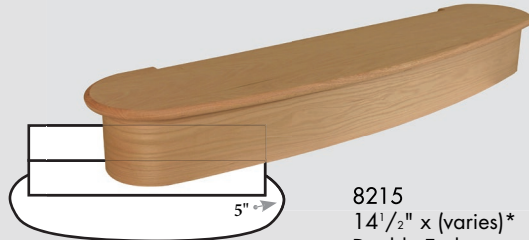
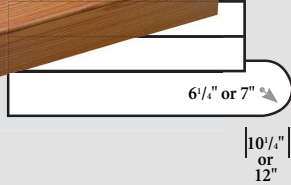

8215
14 1/2" x (varies)*
Double End
Bowed Starting Step

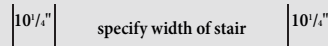

*available in any length

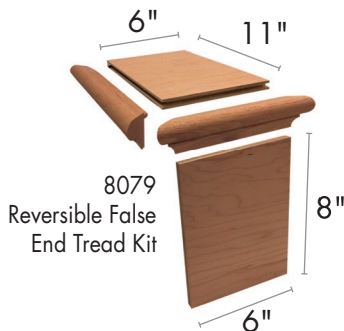

8079
Reversible
False
End Tread Kit



8072
6" x 11"
Closed False End
Tread Kit

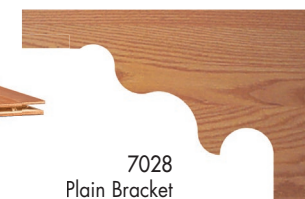

7028
Plain Bracket
11 1/2" x 8 1/8" x 5 1/16"



7029
Scroll Bracket
11 1/2" x 7 3/4" x 5 1/16"

HANDRAIL FITTINGS

slawparts



-08
Coped End



-20
Tandem Cap



-19
Opening Cap



-09
Returned End



-11
Level Quarterturn



-11-135
1/8 Turn



-21
Quarterturn Cap



-21-135
1/8 Turn

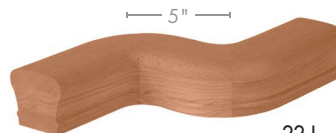

-22-L
S-Fitting

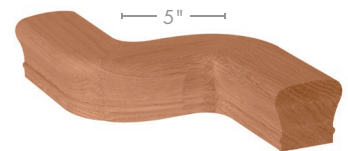

-22-R
S-Fitting



-97-2
2 Rise Straight
Gooseneck
with cap



-99-2
2 Rise Straight
Gooseneck



-88-2
2 Rise Straight
Gooseneck with
tandem cap



-60-2
Left Hand
2 Rise
1/4 Turn
Gooseneck
with cap



-65-2
Right Hand
2 Rise
1/4 Turn
Gooseneck
with cap



-81-2
Left Hand
2 Rise
1/4 Turn
Gooseneck
with cap



-86-2
Right Hand
2 Rise
1/4 Turn
Gooseneck
with cap



-50-2
Left Hand
2 Rise
1/4 Turn
Gooseneck



-55-2
Right Hand
2 Rise
1/4 Turn
Gooseneck



-71-2
Left Hand
2 Rise
1/4 Turn
Gooseneck



-76-2
Right Hand
2 Rise
1/4 Turn
Gooseneck



-90-2
Left Hand
2 Rise
180° Turn
Gooseneck



-95-2
Right Hand
2 Rise
180° Turn
Gooseneck



12 1/2"

RD
Rail Drop

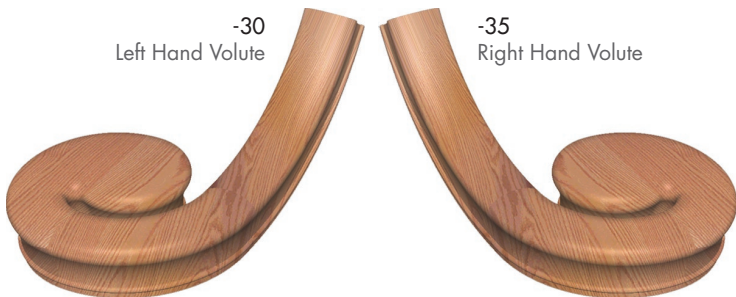

**Handrail Fittings
P R E F I X E S**

Add prefix to fitting number that corresponds with handrail styles.

70- for 6010 handrail
 72- for 6210 handrail
 75- for 6519 handrail
 77- for 6710 handrail
 79- for 6910 handrail
 56- for 5600 handrail
 57- for 5700 handrail
 91- for 9100 handrail

HANDRAIL

stair parts



6040

We offer straight and bending rails up to 24 feet in length!



1 1/2" · flat bottom



1 1/2" · full round



1 3/4" · full round



1 3/4" · flat bottom



2" · full round



2" · flat bottom



3" · full round



3" · flat bottom



6042
2 1/4" x 1 1/16"



5600
2 5/8" x 1 7/8"
flat bottom



6010
2 1/4" x 2 3/8"



5600
2 5/8" x 1 7/8"
full round



5700*
2 1/2" x 1 3/4"



6210
2 5/8" x 2 3/8"



9100
2 1/4" x 2 3/8"



6400*
3" x 2 1/4"



7600
2 5/8" x 2 1/4"



6519
2 5/8" x 3"



6910
2 3/8" x 2 5/8"



6710
2 5/8" x 2 3/4"



6000-S
3/4" x 2 1/2"
plowed 1 1/4"



6000
1 5/8" x 2 3/4"
plowed 1 1/4"



6001-S
3/4" x 2 1/2"
plowed 1 3/4"



6001
1 5/8" x 2 3/4"
plowed 1 3/4"



6002
1 5/8" x 2 3/4"



6004
Fillet
1 1/4"



6005
Shoerail
1 1/4"

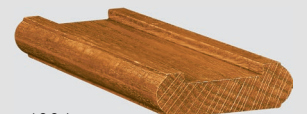

6006
Shoerail
1 3/4"

Above Rails available plowed for square top balusters.
Large amount of special species handrail in stock for immediate shipment.
*All profiles available in bending unless noted.



6007
Fillet
1 3/4"



6203*
Wall Handrail
1 5/8" x 5 1/2"



Bending Rail
6910 B.

*All profiles available in bending unless noted.

WALLRAIL

accessories

brackets



dull chrome
3002



bright brass
3002



satin nickel
3002



bright chrome
3002



antique brass
3002



satin black
3002



oil rubbed bronze
3002

fittings

Wall Rail Fittings for 6040-6042 and Round Profiles



7006
up easing



7023
quarter turn



7024 full round
up easing



7025 full round
over easing

ACCESSORIES

stairparts



7007
Double End Lag

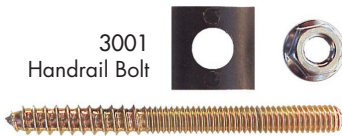

3001
Handrail Bolt



3008 Suretite
Newel Fastener

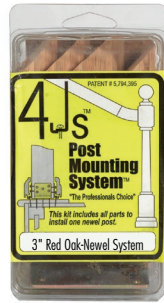

3009
3" Newel Mounting System



3019
3 1/2" Newel
Mounting System



7017 Round Rosette
3/4" x 4"



7033 Rectangular Rosette
4 5/16" x 6"



7037 Oval Rosette
3/4" x 4" x 5 1/2"



7037-L Large Oval Rosette
4 1/2" x 6 1/2"



7002
Pin-EZ



3000
Tapered Plug
1"



7001
Newel Mounting Plate



7003
Threaded Insert



TREADS CONT.



8080
Return Nosing
1 1/16" x 1 1/4"

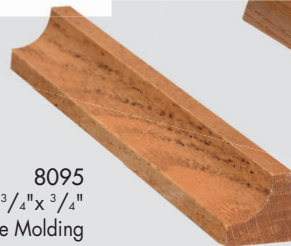

8095
3/4" x 3/4"
Cove Molding



8096
Shoe Molding
1/2" x 3/4"



8078
false tread molding
1 1/2" x 1 13/16"



8090
3 1/2" landing tread



8090-5
5 1/2" landing tread



1100
3/4" x 11 1/2"
skirt board



iron



9000TB
plain



9001TB
single twist



9002TB
double twist



9009TB
7" x 24" S Scroll



9003TB
single basket



9004TB
double basket



9006
single knuckle



9007
double knuckle

Powder Coat Finish Options



SB



CV



OB



FB

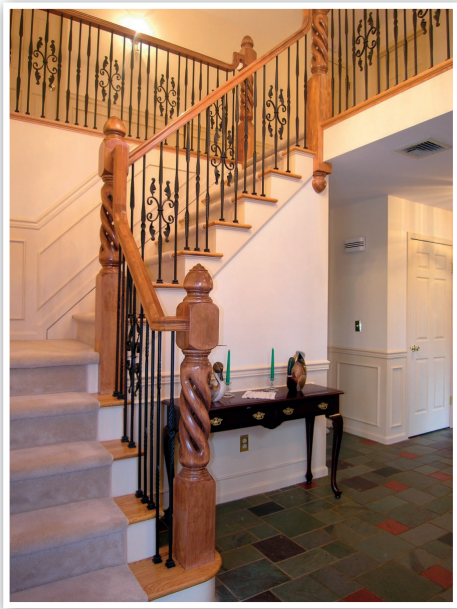

COLOR CODE INDEX

- SB satin black
- CV copper vein
- OB oil rubbed bronze
- FB flat black

▼ shoes



9061BS
1/2" base shoe
no set screw



9067EF
1/2" easy fit
round shoe



9063RS
1/2" rake shoe
with set screw



9062BS
1/2" base shoe
with set screw



9064AK
1/2" adjustable
knuckle





custom

CUSTOM
turnings



3 1/2" x 48"



octagonal

3 1/2" x 48"



4" x 60"



1 3/4" x 42"



10" x 10'
column



Most large columns
are constructed with
hollow centers.



8" x 8'
column

CAPS & BASES



5" x 9"



3 1/2" x 10"



3 1/2" x 14"
Tuscan Cap



6" x 14"
Tuscan Base

create your own
Supply your own CAD drawings,
or we can create one.
.....
We offer custom columns up to
12 1/2' long and 17 1/2" in diameter!



1 3/4" x 39"



3 1/2" x 48"



3011
w/Rope
Twist
3 1/2" x 48"



36" x 5 1/8"



12" x 28 1/2"



15" x 28 1/2"

Carving available on Custom Turnings.

finials



Finial
3 1/2" x 6 3/8"



Carved Acorn Finial
4 1/2" x 7"



Carved Finial
5 1/8" x 8"



Fluted
F-8611
3 1/4" x 48"



Flourentine
FLTE8600
2" x 42"



Barley Twist
BT8600
2" x 42"



Flourentine
FLTE8645
3 1/4" x 60"



Hollow Flute
HF8760
5 1/2" x 60"



Flourentine
FLTE8660
5 1/2" x 50"



Barley Twist
BT8645
3 1/4" x 60"



Ribbon Twist
RT8600
2" x 42"



Open Rope Twist
ORT8600
2" x 42"



Open Rope Twist
ORT8640
3 1/4" x 48"



Open Rope Twist
ORT8660
5 1/2" x 50"

We feel privileged to offer this new, fine, handcrafted line of turnings.



create your own

Build the stairway of your dreams, our creative designers will take your ideas and bring them to reality. This brochure showcases a few of our fine custom turnings, railings and posts. Our modern equipment allows us to craft straight and bending rails up to 24 feet in length. Not only can we build the ideal interior stairway, but also offer beautiful, exterior cedar posts for your pergola or porch.



kitchen AND bath



Gustavia
3 1/2" x 36"



Venice
3 1/2" x 36"



Lakeside
4 1/4" x 36"



Island Leg, Fluted Rhode Island
5 1/2" x 36"



Flourentine Montana
3 1/2" x 36"



Fluted Montana
3 1/2" x 36"



Barley Twist Montana
3 1/2" x 36"

These turnings are created specifically for Kitchen & Bath or fireplace mantels.



climbing volute

your quality stair parts distributor

